

# Linux for System z at Nationwide Insurance From Woe to Whoa!



Jim Vincent

SHARE 111 - August 2008



# Overview and Disclaimer



Disclaimer:

The content of this presentation is for information only and is not intended to be an endorsement by Nationwide Insurance. Each site is responsible for their own use of the concepts and examples presented.

First, a word from our announcer:

With a few exceptions, this is an overview! Where possible there are technical details you may be able to use. As you frequently hear when anyone asks for recommendations, “**IT DEPENDS**” is the answer and it applies here too. The information in this session is based on *our* experiences as long-time VM-ers building virtual Linux farms.

Interaction is good! Please ask questions whenever you want. We'll all get the most out of this session that way.



# Topics

---



- Our Linux Decision History
- Our Environment
- What do we expect Linux to do for us
- Direction – What drives our project
- A learning process
- Conclusions

# Our Linux Decision History

## The story of Woe



- 2000 – Marist Distribution (based on Red Hat)
  - First offering of install lab at SHARE
  - Built one in-house to play with
  - Wrote up recommendation to management; Little interest or direction
- 2002 – SUSE 7
  - Basic demo of Apache and Samba
  - Wrote up recommendation to management; Little interest or direction
- 2004 – Red Hat
  - Intel, pSeries and zSeries pilots planned and started
  - zSeries waned quickly and work ceased

# Our Linux Decision History

## The story of Whoa!!



- 2005 – The fun begins!
  - New Emphasis on virtualization
    - Fasten your seat-belts!
- Proof of concept system originally had three small business applications
  - Then we had at least seven with more wanting on ASAP
- *Our* initial thought was to tackle File/Print sharing
  - Naaaw! That’s too easy – we started with J2EE servers!
  - WAS, WAS Portal, IHS, DB/2, etc.
    - The Hoover’s of the zLinux workload
- Anticipated having about 120 total servers by year-end 2005
  - It is growing faster than anyone thought it would

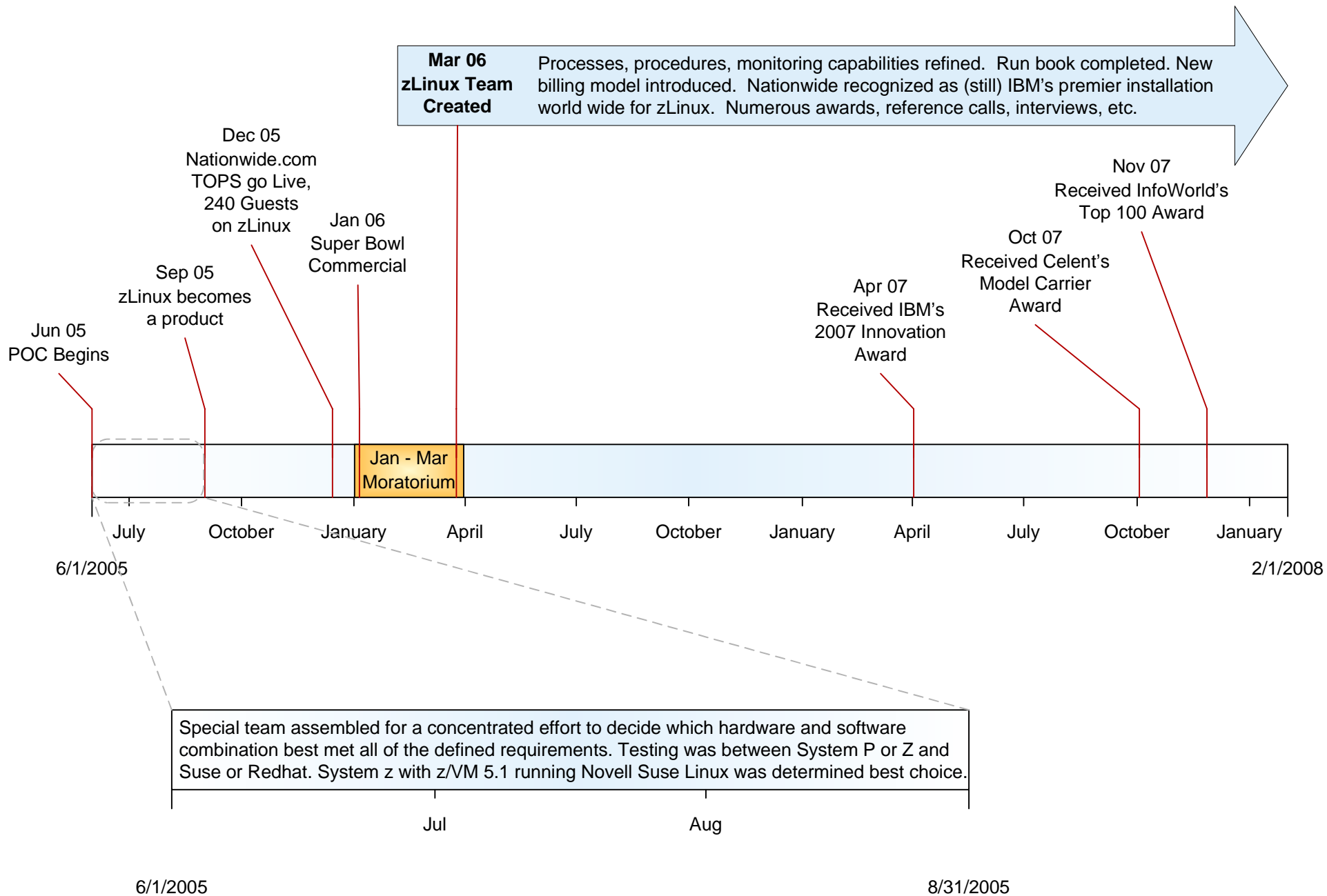

# Be careful what you ask for! 😊

## Things grew fast!



*And I thought we were busy **before** we got Linux!*  
Rick Barlow, Aug 1, 2006

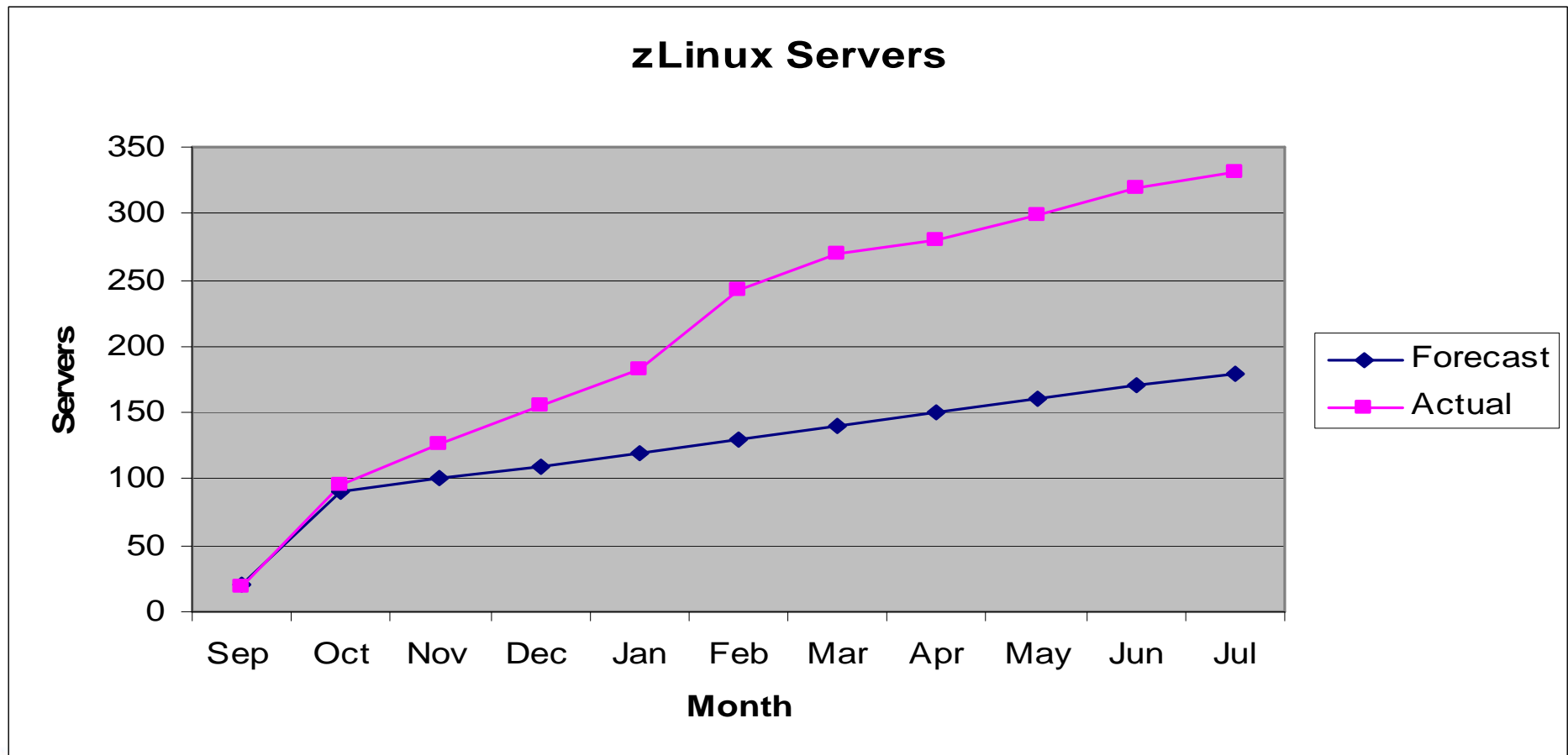

# Environment – then...



- Before we got serious about Linux
  - 3 z900 processors; mostly z/OS; models 104, 107, 1C8
  - The 104 had 24GB of storage and ran:
    - 4 z/OS LPARs
    - 1 Coupling Facility LPAR (ICF)
    - 2 relatively small z/VM LPARs which used about 200+ MIPs
- For Linux **pilot**

There was capacity to create another small z/VM LPAR on the 104.

  - Started with 1 and ended up with 3 dedicated IFL engines
  - 8 GB memory
    - 6 GB Central; 2 GB Expanded



# Environment – now...



- **Today** – 2 new z9s dedicated to Linux
  - 17 IFL engines for test/dev and 18 IFL engines for production
  - 352GB memory for test, 240GB for production
  - 4 z/VM 5.3 LPARs on each
    - 1 additional test LPAR on development box for sandbox
    - 9 total LPARs
  - **Growing FAST!**
    - Total of 517 zLinux servers (as of June 18)
      - 167 production and 350 test/dev
    - Growing UP instead of OUT
      - Had been forecasted to be at 1000+ servers by now
      - Over 1630 JVMs



+

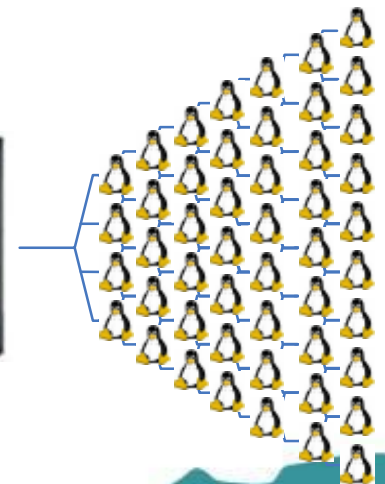

# IBM z9 Platform (test/dev)

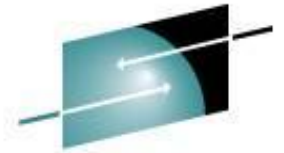

**SHARE**  
Technology • Connections • Results

**Processors**  
16 IFLs  
Max 38  
(42%)

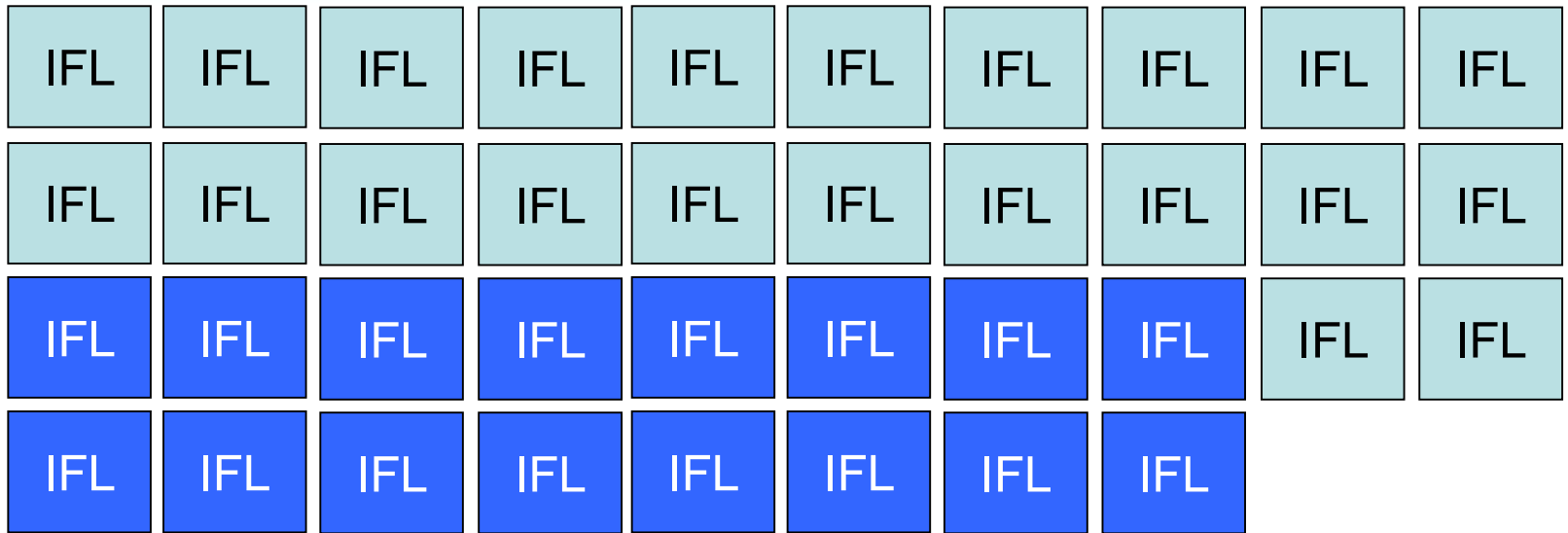

**Memory**  
352GB  
Max 512GB  
(69%)  
(Each block is 2GB)

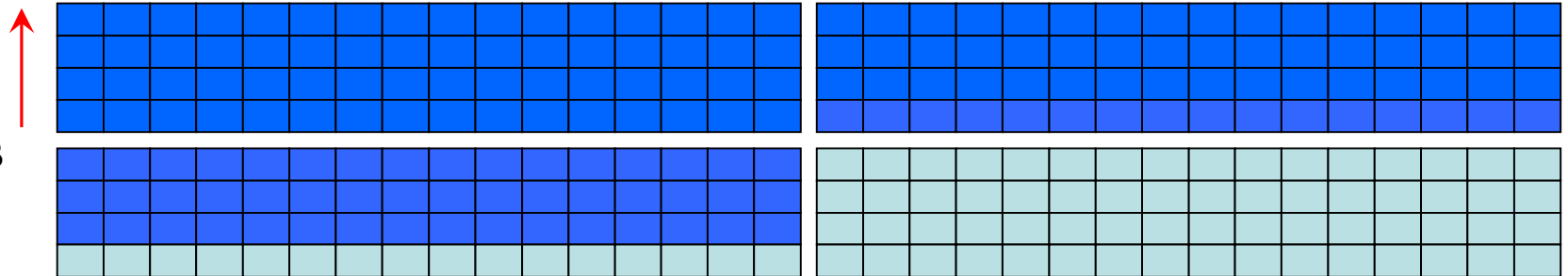

**Network**  
10 OSA Cards  
Max 48  
(20%)



# Problems to solve



- Server Proliferation
  - Space that previously was required to house a few mainframes is now mostly consumed by multitudes of all type of servers, network hardware, other support hardware
    - Sun, HP, multiple brands of Intel
    - Routers and switches
    - SAN, NAS, data warehouse, etc

# Problems to solve



- Provisioning
  - Many requirements for stand-alone server
    - Order and obtain hardware – several weeks
    - Physical install
    - Optional external disk subsystem configuration and connection
    - Network configuration and connection
    - OS load
    - Middle-ware load
    - Application load
  - Many hands and significant time
    - Usually would take several weeks (6-8 at least) or more before the customer would get the box

# Vision and Expectations



- Physical space and environmental reduction
  - One z990 IFL engine can support 10-30 (or more) virtual servers
  - A z990 can have up to 32 IFL engines so it *could* replace 300+ servers **Fact: we had 330+ large servers running on 15 IFLs between two z990s**
  - Significant savings in physical space, power, cooling
- Reduce network complexity
  - A small number of physical network connections (OSAs with VSWITCH) can support all of the virtual servers in contrast to every stand-alone server having 2 or more interfaces it must manage
- Quicker provisioning
  - Setting up new server can be as fast as your disk copy tool
    - Depends on software needed on server and amount of manual effort

# Direction – getting Linux on z rolling



- Start with technicians then try to influence organization
  - Common with existing zSeries shops; especially those with z/VM already in their shop ("skunk works")
    - Build something and demonstrate function and don't bother to tell anyone what it is and where it is running
    - “We will build it and they will come”
    - Be prepared to have the idea crash and burn when presented to management
  - Challenges
    - Organization barriers – turf wars
    - ‘Opinions’ used instead of good technical evaluations and decisions
    - Workload – real work vs. “fun” stuff like Linux



# Direction – getting Linux on z rolling



- Start with CIO (upper management) and direct organization
  - More common as industry accepts zSeries virtualization solution
  - Driven by business need (e.g. space restraints, rapid growth, etc)
  - Typically causes more structured implementation and wider acceptance
    - Some will still kick and scream, though not real loud

# Learning – everyone has to!



- Mainframe methodology differs from non-mainframe methodology
  - Repeatability automated processes versus hands-on "hacker" install
    - Typical mainframe person accustomed to well-documented, repeatable processes that permit automation for multiple installs
    - Preference for install once and copy rather than repeated installation
    - Expect software to be installed in one location and configuration in a common location
  - Different philosophy for management:
    - Privilege levels differ for installing OS, installing middle-ware, configuring
  - Different maintenance philosophy
    - Expect to regularly upgrade software on all servers



# Distributions

- There are a few options to choose from when selecting a distribution for System z (S/390)
- There are only a ‘few’ parts that are different in the Linux code path to get it to work on z/VM – just a few...

## Linux for S/390 Kernel Code Tree

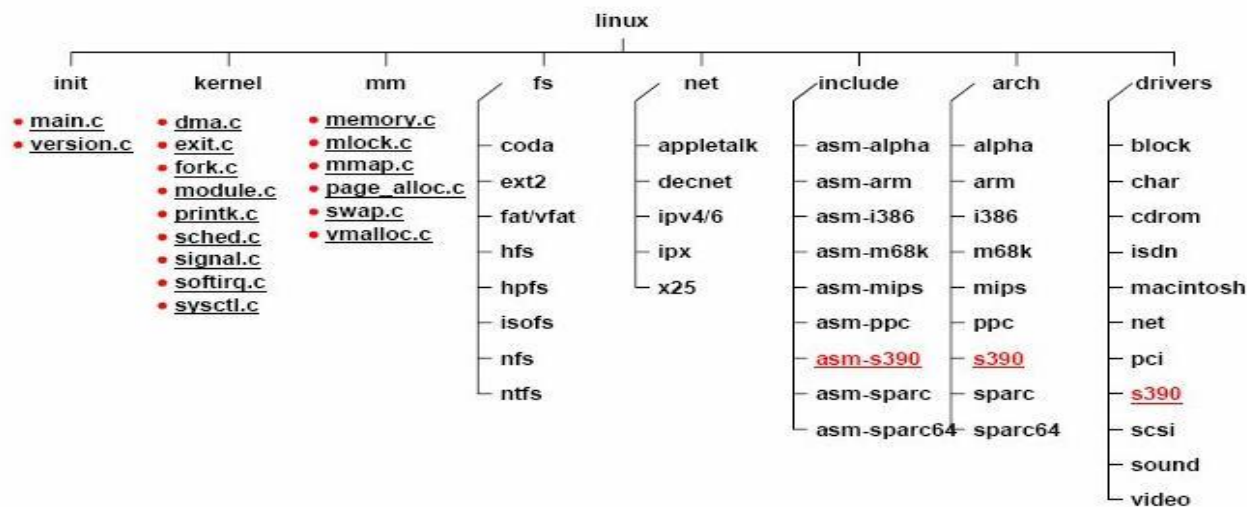

# Distributions



- We picked and started with Red Hat and SUSE because they seemed to offer the best support for a large enterprise implementation
- Documentation differs greatly
  - Red Hat
    - Installation instructions begin at loading the RAM disk into memory
    - It appears to have been an afterthought
  - SUSE
    - Shows how to build the virtual server directory and copy the RAM disks to VM
    - It seems to understand the zSeries and z/VM environment
  - Both
    - Incomplete (inadequate) documentation of install parm information for all environments
      - Some not documented
      - Little more than syntax
      - Incomplete or no examples

# Distributions – our observations



- Default package list
  - Red Hat
    - Large list of packages in minimum load
    - Security template required omitting load, turning off or disabling many packages
    - Installation required more hands-on and a lot of Google
  - SUSE
    - Smaller list of packages in minimum load – basic runnable Linux
    - Security template required only a handful of changes
    - Installation seemed to be smoother

# Linux Basics for z/VMers



- Even z/VM Sysprogs need to understand what Linux is up to.
  - What we know about running VM applications has an impact on how Linux is built on VM and knowing Linux to some degree helps get the points across to the Linux admins
  - Apply some mainframe disciplines / history / concepts to virtual Linux
- Learn how new devices are added, defined and identified in Linux for the distribution you are using.
  - Learn LVM too
    - Differs depending on distribution (kernel level and/or LVM level)
    - Using CKD DASD for virtual servers is likely to cause you to use it
- Learn the terminology differences
  - Like “Storage” vs “DASD” and “Memory” vs “Storage” !

# Cloning servers



- Cloning:
  - There are numerous ways to clone Linux images
    - PICK ONE and stick to it – it usually is not trivial work to set up
    - Once you start using it, switching to a different way will be time consuming
  - If you have hardware disk duplication available (IBM Flashcopy, STK Snapshot), it can be a huge benefit to cloning
    - If not, DDR has to be used (slow) or a third-party copy tool (HiDRO)
  - You may want to create "standby" Linux images for quick deployment
    - If you have standard templates for the Linux servers, build a few extras and deploy them as requested
    - Makes you look like a wizard when someone asks for a server and 2 minutes later they can log on to it!

# Cloning servers – my take



- Until a vendor solution is obtained, I rolled my own
  - Dirmaint used for directory maintenance... *sigh*
  - DDR (now HiDRO) for large-volume copy due to storage vendor choice and no tool support for z/VM
  - Multi-stage process so that things can be fixed if they have a glitch
    - *Otherwise known as a “finger check” in the control data*
- A server can be built from scratch in < 30 minutes
  - My personal best is 28 WAS/Portal servers in 1 hr. 15 mins.
- A picture may tell it best...

# Cloning / server builds

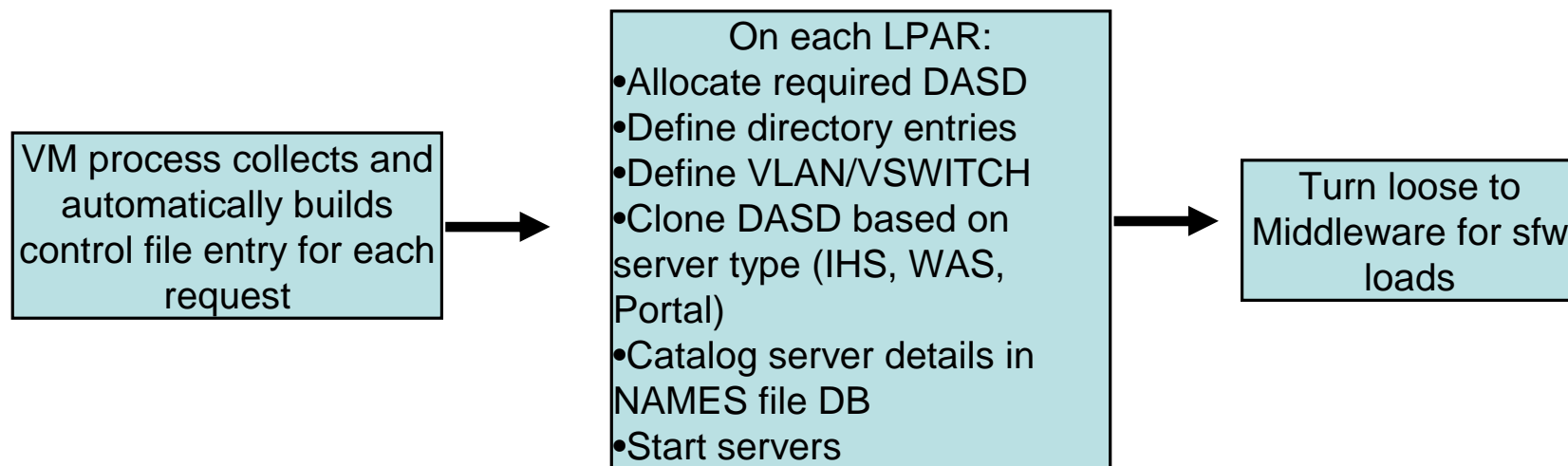
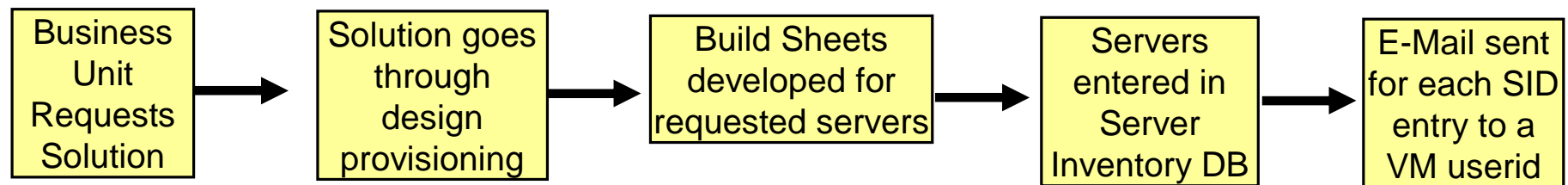

Our server build SLA is 10 days; goal is 72 hours from initial request to fully loaded.

99% of all provision requests are done in less than 12 hours now.

# Linux workloads



- Linux on zSeries virtual servers *may* be able to run with small(er) memory (storage) sizes
  - "It depends" on what will run and in how much memory
  - A basic Linux virtual server can easily run on 64MB of memory
  - An IBM HTTP Server can probably run in 128-256MB depending on the number of static pages and CGIs, etc
  - An IBM WAS Server probably needs 512MB-1GB
  - An IBM WAS Portal or DB server probably needs 2G or more
  - There are a lot of simpler application options!
    - Firewall
    - DNS
    - Web server
    - File and Print serving



# Linux workloads / applications



- *Any* virtualization brings out the best and worst of applications
  - Bad things shine like the sun in Aruba when they are virtualized
    - Memory leaks
    - Spin loops
    - Poor design / configurations
    - Logging and debugging options
    - Intense computations
- Fixing any issues results in a much tighter, better performing application
  - And you can put more than one of them on a single virtual Linux server too

# "Experts"? What we learned...



"My definition of an expert in any field is a person who knows enough about what's really going on to be scared." - PJ Plauger

- “Total Experts” - Do they really exist?
  - There are many people with varying levels of experience in specific areas
  - There are few (if any) who know enough about *everything*
  - Make friends with people who have knowledge in:
    - Mainframe disciplines
    - Linux
    - Network
  - Learn as much as possible about all of these areas
    - Or at least learn how to contact the right person when you need to!

# The Tool Belt



- As the zLinux project continued, it was fairly obvious that providing some “basic” tools would help everyone
- Access to details about the servers
- Access to easy-to-read CPU charts & information on resource usage by server
- A one-stop panel to see the big picture at once

# The zLinux Database – all the details

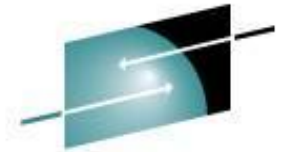

**SHARE**  
Technology • Connections • Results

Main LPARs System Overview | Gmail - Inbox | VM zLinux Server Database

## zLinux Server Database Report

Select the fields to display:

<input type="checkbox"/> VM GuestID	<input checked="" type="checkbox"/> Tech Contact	<input type="checkbox"/> Comments	<input type="checkbox"/> Memory	<input type="checkbox"/> CPUs	<input checked="" type="checkbox"/> IP Address	<input type="checkbox"/> NetBU IP Address	<input type="checkbox"/> DR IP Address	<input type="checkbox"/> NetBU DR IP Address	<input type="checkbox"/> VIPs	<input type="checkbox"/> Service Tier
<input checked="" type="checkbox"/> LPAR	<input checked="" type="checkbox"/> Bus. Contact	<input checked="" type="checkbox"/> Environment	<input type="checkbox"/> SHARE	<input type="checkbox"/> Storage	<input checked="" type="checkbox"/> IP VSwitch	<input type="checkbox"/> NetBU IP VSwitch	<input type="checkbox"/> DR IP VSwitch	<input type="checkbox"/> NetBU DR IP VSwitch	<input type="checkbox"/> DR VIPs	<input checked="" type="checkbox"/> Status/Build Date
<input type="checkbox"/> Console	<input type="checkbox"/> Charge Disb Code	<input type="checkbox"/> Load Type	<input type="checkbox"/> OS Storage	<input type="checkbox"/> SAN Storage	<input checked="" type="checkbox"/> IP VLAN	<input type="checkbox"/> NetBU IP VLAN	<input type="checkbox"/> DR IP VLAN	<input type="checkbox"/> NetBU DR IP VLAN		<input checked="" type="checkbox"/> Gold Version
<input checked="" type="checkbox"/> Description			<input type="checkbox"/> SAN LUNs							<input type="checkbox"/> AlertCPU
										<input type="checkbox"/> AlertIDs

Filter: szvmjt  Hide Links  Show Clones

Boolean search available. Use symbols & (and) | (or) between words. OR search is implied.

#	HostName	LPAR	Description	Tech Contact	Business Contact	Env	IP	VSwitch	VLAN	Built/Status	Gold
1	SZVMJT001	VST	From-scratch build server	HUFFNEM / Huffner, Michael J. / 1-614-249-7662	WOECKER / Woekener, Robert J. (Buzz) / 1-614-249-7895	DEV	10.220.168.10	TOOL2	3740	2005-08-01	Latest
2	SZVMJT002	VST	Next-GOLD build server	HUFFNEM / Huffner, Michael J. / 1-614-249-7662	WOECKER / Woekener, Robert J. (Buzz) / 1-614-249-7895	DEV	10.220.168.11	TOOL2	3740	2005-08-01	Latest
3	SZVMJT003	VST	Clone-Test Box	HUFFNEM / Huffner, Michael J. / 1-614-249-7662	WOECKER / Woekener, Robert J. (Buzz) / 1-614-249-7895	DEV	10.220.168.12	TOOL2	3740	2006-03-13	V1.4
4	SZVMJT004	VST	NSC zLinux group test box	HUFFNEM / Huffner, Michael J. / 1-614-249-7662	WOECKER / Woekener, Robert J. (Buzz) / 1-614-249-7895	DEV	10.220.168.188	TOOL1	3740	2006-07-25	V1.4
5	SZVMJT005	VST	NSC zLinux group test box	HUFFNEM / Huffner, Michael J. / 1-614-249-7662	WOECKER / Woekener, Robert J. (Buzz) / 1-614-249-7895	DEV	10.220.168.189	TOOL2	3740	2006-07-25	V1.4
6	SZVMJT006	VST	NSC Omegamon Mgmt, TOOLS, Intranet	HUFFNEM / Huffner, Michael J. / 1-614-249-7662	WOECKER / Woekener, Robert J. (Buzz) / 1-614-249-7895		10.220.168.31	TOOL2	3740	2006-06-06	V1.4
7	SZVMJT007	VST	NSC Omegamon Tivoli Collector Agent, TOOLS, Intranet	HUFFNEM / Huffner, Michael J. / 1-614-249-7662	WOECKER / Woekener, Robert J. (Buzz) / 1-614-249-7895		10.220.168.32	TOOL2	3740	2006-06-06	V1.4
8	SZVMJT008	VS2	NSC NSC, APP, Intranet	HUFFNEM / Huffner, Michael J. / 1-614-249-7662	WOECKER / Woekener, Robert J. (Buzz) / 1-614-249-7895	TOOLS	10.220.168.48	TOOL1	3740	2006-10-27	V1.5
9	SZVMJT009	VST	NSC shared root, APP, Intranet	HUFFNEM / Huffner, Michael J. / 1-614-249-7662	WOECKER / Woekener, Robert J. (Buzz) / 1-614-249-7895	TOOLS	10.220.168.52	TOOL1	3740	2006-11-16	v1.5
10	SZVMJT010	VST	NSC shared root, APP, Intranet	HUFFNEM / Huffner, Michael J. / 1-614-249-7662	WOECKER / Woekener, Robert J. (Buzz) / 1-614-249-7895	TOOLS	10.220.168.53	TOOL2	3740	2006-11-16	v1.5
11	SZVMJT011	VST	NSC shared root, APP, Intranet	HUFFNEM / Huffner, Michael J. / 1-614-249-7662	WOECKER / Woekener, Robert J. (Buzz) / 1-614-249-7895	TOOLS	10.220.168.54	TOOL2	3740	2006-11-16	v1.5
12	SZVMJT012	VST	NSC shared root, APP, Intranet	HUFFNEM / Huffner, Michael J. / 1-614-249-7662	WOECKER / Woekener, Robert J. (Buzz) / 1-614-249-7895	TOOLS	10.220.168.55	TOOL1	3740	2006-11-16	v1.5
13	SZVMJT013	VST	NSC zLinux Team Development, APP, Intranet	HUFFNEM / Huffner, Michael J. / 1-614-249-7662	WOECKER / Woekener, Robert J. (Buzz) / 1-614-249-7895	TOOLS	10.220.168.56	TOOL1	3740	2006-11-21	V1.5
14	SZVMJT014	VST	NSC zLinux Team Development, APP, Intranet	HUFFNEM / Huffner, Michael J. / 1-614-249-7662	WOECKER / Woekener, Robert J. (Buzz) / 1-614-249-7895	TOOLS	10.220.168.57	TOOL2	3740	2006-11-21	V1.5
15	SZVMJT015	VST	NSC zLinux Team Development, APP, Intranet	HUFFNEM / Huffner, Michael J. / 1-614-249-7662	WOECKER / Woekener, Robert J. (Buzz) / 1-614-249-7895	TOOLS	10.220.168.58	TOOL2	3740	2006-11-21	V1.5

# CPU overview

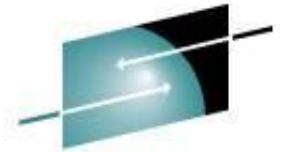

**SHARE**  
Technology • Connections • Results

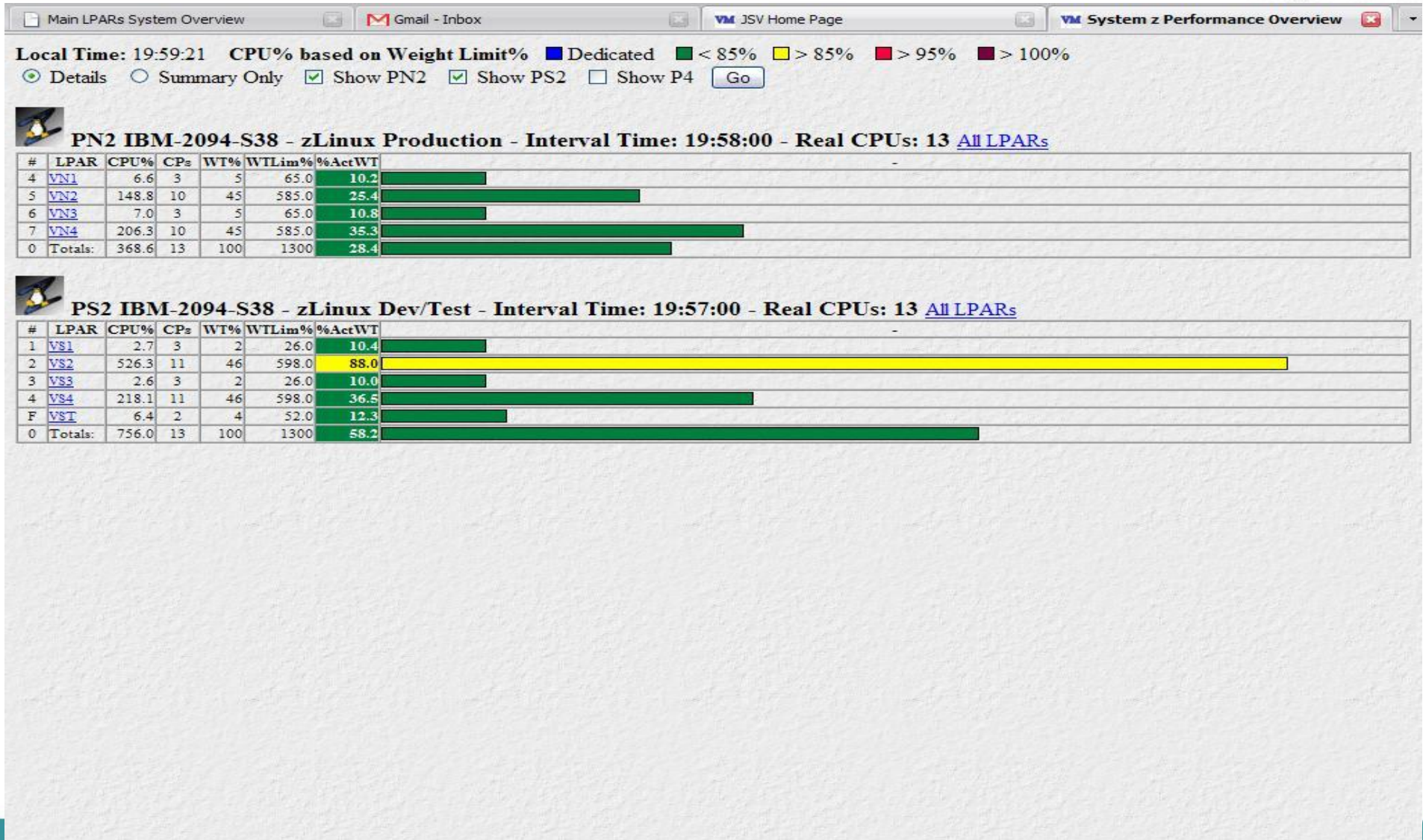

# The big picture – all in one place

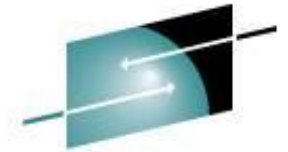

**SHARE**

5 - Results

## Main LPARs System Overview - Local Time 19:58:19

VN2					VN4																																																																																																																												
z/VM CPU 2094 SERIAL 0FBFCD DATE 08/01/07 START 19:58:00 END 19:59:00					z/VM CPU 2094 SERIAL 04BFCD DATE 08/01/07 START 19:58:01 END 19:59:01																																																																																																																												
AVGPROC-015% 10 MODEL-2094 SERIAL-FBFC					AVGPROC-019% 10 MODEL-2094 SERIAL-4BFCD																																																																																																																												
CPU-148% USER-143% PROB-135% SYST-5% OVHD-8% IDLE-849% PAGING-13/SEC					CPU-194% USER-185% PROB-172% SYST-9% OVHD-12% IDLE-802% PAGING-29/SEC																																																																																																																												
INQUEUE-00101 Q0-00003 Q1-00023 Q2-00012 Q3-00063					INQUEUE-00105 Q0-00003 Q1-00028 Q2-00015 Q3-00058																																																																																																																												
ELIG-00000 LOADING-00000					ELIG-00000 LOADING-00000																																																																																																																												
<table border="1"> <thead> <tr> <th>Host/uid:</th> <th>CPU%</th> <th>IO/Sec</th> <th>Pg/Sec</th> <th>Description</th> </tr> </thead> <tbody> <tr><td>NZVMAS740</td><td>27.6</td><td>4.9</td><td>0.4</td><td>P&amp;C NorthStar, App, PROD</td></tr> <tr><td>NZVMAS807</td><td>10.5</td><td>3.2</td><td>2.2</td><td>NSC Tops, Was/MQ App, PROD</td></tr> <tr><td>NZVMAS804</td><td>6.9</td><td>1.9</td><td>0.2</td><td>NSC Nationwide.Com, WAS App, PROD</td></tr> <tr><td>NZVMAS738</td><td>6.4</td><td>1.3</td><td>0.6</td><td>P&amp;C Horizon Claims, App, PROD</td></tr> <tr><td>NZVMAS728</td><td>6.3</td><td>1.3</td><td>1.2</td><td>P&amp;C Shared, WAS, PROD</td></tr> <tr><td>NZVMAS734</td><td>5.6</td><td>1.7</td><td>0.5</td><td>P&amp;C Northstar, App, PROD</td></tr> <tr><td>NZVMDS702</td><td>4.7</td><td>3.7</td><td>0.1</td><td>P&amp;C Agent Gateway, DB, PROD</td></tr> <tr><td>NZVMAS702</td><td>4.0</td><td>2.0</td><td>0.1</td><td>P&amp;C Vin / Vms Lookup / Nol, WAS App, PROD</td></tr> <tr><td>NZVMAS718</td><td>3.9</td><td>1.3</td><td>1.0</td><td>P&amp;C MarketLink, App, PROD</td></tr> <tr><td>NZVMAS828</td><td>3.6</td><td>1.8</td><td>3.4</td><td>NSC Assoc Resiliency, WAS, PROD</td></tr> <tr><td>NZVMWS824</td><td>3.5</td><td>2.3</td><td>0</td><td>NSC Assoc Resiliency, IHS, PROD</td></tr> </tbody> </table>					Host/uid:	CPU%	IO/Sec	Pg/Sec	Description	NZVMAS740	27.6	4.9	0.4	P&C NorthStar, App, PROD	NZVMAS807	10.5	3.2	2.2	NSC Tops, Was/MQ App, PROD	NZVMAS804	6.9	1.9	0.2	NSC Nationwide.Com, WAS App, PROD	NZVMAS738	6.4	1.3	0.6	P&C Horizon Claims, App, PROD	NZVMAS728	6.3	1.3	1.2	P&C Shared, WAS, PROD	NZVMAS734	5.6	1.7	0.5	P&C Northstar, App, PROD	NZVMDS702	4.7	3.7	0.1	P&C Agent Gateway, DB, PROD	NZVMAS702	4.0	2.0	0.1	P&C Vin / Vms Lookup / Nol, WAS App, PROD	NZVMAS718	3.9	1.3	1.0	P&C MarketLink, App, PROD	NZVMAS828	3.6	1.8	3.4	NSC Assoc Resiliency, WAS, PROD	NZVMWS824	3.5	2.3	0	NSC Assoc Resiliency, IHS, PROD	<table border="1"> <thead> <tr> <th>Host/uid:</th> <th>CPU%</th> <th>IO/Sec</th> <th>Pg/Sec</th> <th>Description</th> </tr> </thead> <tbody> <tr><td>NZVMAS741</td><td>23.3</td><td>46.2</td><td>0.2</td><td>P&amp;C NorthStar, App MQ, PROD</td></tr> <tr><td>NZVMAS813</td><td>18.4</td><td>12.0</td><td>0</td><td>Gates TOPS, WAS/MQ/Rpt, PROD</td></tr> <tr><td>NZVMAS739</td><td>12.7</td><td>2.8</td><td>2.0</td><td>P&amp;C NorthStar, App, PROD</td></tr> <tr><td>NZVMAS808</td><td>8.5</td><td>2.3</td><td>0</td><td>NSC Tops, Was/MQ App, PROD</td></tr> <tr><td>NZVMAS733</td><td>8.1</td><td>4.4</td><td>0.7</td><td>P&amp;C Northstar, App, PROD</td></tr> <tr><td>NZVMAS727</td><td>8.0</td><td>1.3</td><td>0.5</td><td>P&amp;C Shared, WAS, PROD</td></tr> <tr><td>NZVMAS833</td><td>7.1</td><td>0.8</td><td>0.4</td><td>NSC LMS, App, PROD</td></tr> <tr><td>NZVMAS805</td><td>6.3</td><td>1.8</td><td>4.4</td><td>NSC Nationwide.Com, WAS App, PROD</td></tr> <tr><td>NZVMAS729</td><td>6.1</td><td>5.4</td><td>0.5</td><td>P&amp;C Shared, WAS, PROD</td></tr> <tr><td>NZVMDS701</td><td>5.6</td><td>11.1</td><td>0.3</td><td>P&amp;C Agent Gateway, DB, PROD</td></tr> <tr><td>NZVMAS737</td><td>4.7</td><td>1.7</td><td>1.3</td><td>P&amp;C Horizon Claims, App, PROD</td></tr> </tbody> </table>					Host/uid:	CPU%	IO/Sec	Pg/Sec	Description	NZVMAS741	23.3	46.2	0.2	P&C NorthStar, App MQ, PROD	NZVMAS813	18.4	12.0	0	Gates TOPS, WAS/MQ/Rpt, PROD	NZVMAS739	12.7	2.8	2.0	P&C NorthStar, App, PROD	NZVMAS808	8.5	2.3	0	NSC Tops, Was/MQ App, PROD	NZVMAS733	8.1	4.4	0.7	P&C Northstar, App, PROD	NZVMAS727	8.0	1.3	0.5	P&C Shared, WAS, PROD	NZVMAS833	7.1	0.8	0.4	NSC LMS, App, PROD	NZVMAS805	6.3	1.8	4.4	NSC Nationwide.Com, WAS App, PROD	NZVMAS729	6.1	5.4	0.5	P&C Shared, WAS, PROD	NZVMDS701	5.6	11.1	0.3	P&C Agent Gateway, DB, PROD	NZVMAS737	4.7	1.7	1.3	P&C Horizon Claims, App, PROD
Host/uid:	CPU%	IO/Sec	Pg/Sec	Description																																																																																																																													
NZVMAS740	27.6	4.9	0.4	P&C NorthStar, App, PROD																																																																																																																													
NZVMAS807	10.5	3.2	2.2	NSC Tops, Was/MQ App, PROD																																																																																																																													
NZVMAS804	6.9	1.9	0.2	NSC Nationwide.Com, WAS App, PROD																																																																																																																													
NZVMAS738	6.4	1.3	0.6	P&C Horizon Claims, App, PROD																																																																																																																													
NZVMAS728	6.3	1.3	1.2	P&C Shared, WAS, PROD																																																																																																																													
NZVMAS734	5.6	1.7	0.5	P&C Northstar, App, PROD																																																																																																																													
NZVMDS702	4.7	3.7	0.1	P&C Agent Gateway, DB, PROD																																																																																																																													
NZVMAS702	4.0	2.0	0.1	P&C Vin / Vms Lookup / Nol, WAS App, PROD																																																																																																																													
NZVMAS718	3.9	1.3	1.0	P&C MarketLink, App, PROD																																																																																																																													
NZVMAS828	3.6	1.8	3.4	NSC Assoc Resiliency, WAS, PROD																																																																																																																													
NZVMWS824	3.5	2.3	0	NSC Assoc Resiliency, IHS, PROD																																																																																																																													
Host/uid:	CPU%	IO/Sec	Pg/Sec	Description																																																																																																																													
NZVMAS741	23.3	46.2	0.2	P&C NorthStar, App MQ, PROD																																																																																																																													
NZVMAS813	18.4	12.0	0	Gates TOPS, WAS/MQ/Rpt, PROD																																																																																																																													
NZVMAS739	12.7	2.8	2.0	P&C NorthStar, App, PROD																																																																																																																													
NZVMAS808	8.5	2.3	0	NSC Tops, Was/MQ App, PROD																																																																																																																													
NZVMAS733	8.1	4.4	0.7	P&C Northstar, App, PROD																																																																																																																													
NZVMAS727	8.0	1.3	0.5	P&C Shared, WAS, PROD																																																																																																																													
NZVMAS833	7.1	0.8	0.4	NSC LMS, App, PROD																																																																																																																													
NZVMAS805	6.3	1.8	4.4	NSC Nationwide.Com, WAS App, PROD																																																																																																																													
NZVMAS729	6.1	5.4	0.5	P&C Shared, WAS, PROD																																																																																																																													
NZVMDS701	5.6	11.1	0.3	P&C Agent Gateway, DB, PROD																																																																																																																													
NZVMAS737	4.7	1.7	1.3	P&C Horizon Claims, App, PROD																																																																																																																													
28.0%																																																																																																																																	
VS2					VS4																																																																																																																												
z/VM CPU 2094 SERIAL 02BFBD DATE 08/01/07 START 19:56:00 END 19:57:00					z/VM CPU 2094 SERIAL 04BFBD DATE 08/01/07 START 19:56:00 END 19:57:00																																																																																																																												
AVGPROC-047% 11 MODEL-2094 SERIAL-2BFBD					AVGPROC-019% 11 MODEL-2094 SERIAL-4BFBD																																																																																																																												
CPU-518% USER-507% PROB-488% SYST-11% OVHD-19% IDLE-538% PAGING-65/SEC					CPU-214% USER-206% PROB-198% SYST-7% OVHD-8% IDLE-881% PAGING-41/SEC																																																																																																																												
INQUEUE-00232 Q0-00004 Q1-00076 Q2-00020 Q3-00132					INQUEUE-00223 Q0-00004 Q1-00073 Q2-00029 Q3-00117																																																																																																																												
ELIG-00000 LOADING-00000					ELIG-00000 LOADING-00000																																																																																																																												
<table border="1"> <thead> <tr> <th>Host/uid:</th> <th>CPU%</th> <th>IO/Sec</th> <th>Pg/Sec</th> <th>Description</th> </tr> </thead> <tbody> <tr><td>SZVMDS001</td><td>101.4</td><td>6641.0</td><td>2.4</td><td>P&amp;C Agent Gateway Data, PT</td></tr> <tr><td>SZVMAS551</td><td>98.8</td><td>1.9</td><td>0</td><td>NSC Tops, WAS ND App, DEV</td></tr> <tr><td>SZVMAS430</td><td>95.5</td><td>1.0</td><td>1.1</td><td>P&amp;C NWBH, App, DEV</td></tr> <tr><td>SZVMAS050</td><td>30.4</td><td>0.8</td><td>0.8</td><td>P&amp;C Agent Gateway WAS App, IT</td></tr> <tr><td>SZVMAS028</td><td>7.9</td><td>1.0</td><td>0.5</td><td>P&amp;C, App, PT</td></tr> <tr><td>SZVMAS026</td><td>5.8</td><td>3.3</td><td>0.6</td><td>P&amp;C Customer Endpoint, App, PT</td></tr> <tr><td>SZVMAS504</td><td>5.6</td><td>1.4</td><td>2.1</td><td>NSC Nationwide.com, App, ST</td></tr> <tr><td>SZVMAS032</td><td>5.3</td><td>1.4</td><td>0.6</td><td>P&amp;C Northstar, App, PT</td></tr> <tr><td>SZVMAS044</td><td>4.7</td><td>1.9</td><td>0.7</td><td>P&amp;C NorthStar, App, PT</td></tr> <tr><td>SZVMDS002</td><td>4.7</td><td>7.8</td><td>1.4</td><td>P&amp;C Agent Gateway Data, PT</td></tr> <tr><td>SZVMAS550</td><td>4.4 C</td><td>1.2</td><td>0</td><td>13:49 NSC Nationwide.Com WAS App, IT</td></tr> </tbody> </table>					Host/uid:	CPU%	IO/Sec	Pg/Sec	Description	SZVMDS001	101.4	6641.0	2.4	P&C Agent Gateway Data, PT	SZVMAS551	98.8	1.9	0	NSC Tops, WAS ND App, DEV	SZVMAS430	95.5	1.0	1.1	P&C NWBH, App, DEV	SZVMAS050	30.4	0.8	0.8	P&C Agent Gateway WAS App, IT	SZVMAS028	7.9	1.0	0.5	P&C, App, PT	SZVMAS026	5.8	3.3	0.6	P&C Customer Endpoint, App, PT	SZVMAS504	5.6	1.4	2.1	NSC Nationwide.com, App, ST	SZVMAS032	5.3	1.4	0.6	P&C Northstar, App, PT	SZVMAS044	4.7	1.9	0.7	P&C NorthStar, App, PT	SZVMDS002	4.7	7.8	1.4	P&C Agent Gateway Data, PT	SZVMAS550	4.4 C	1.2	0	13:49 NSC Nationwide.Com WAS App, IT	<table border="1"> <thead> <tr> <th>Host/uid:</th> <th>CPU%</th> <th>IO/Sec</th> <th>Pg/Sec</th> <th>Description</th> </tr> </thead> <tbody> <tr><td>SZVMAS100</td><td>30.0</td><td>0.7</td><td>0.1</td><td>P&amp;C Agent Gateway WAS App, ST</td></tr> <tr><td>SZVMAS110</td><td>11.7 C</td><td>5.9</td><td>2.5</td><td>10:03 P&amp;C Agent Gateway, WAS, ST</td></tr> <tr><td>SZVMAS021</td><td>6.0</td><td>1.8</td><td>0.6</td><td>P&amp;C MarketLink, App, PT</td></tr> <tr><td>SZVMAS031</td><td>5.3</td><td>1.4</td><td>3.4</td><td>P&amp;C Northstar, App, PT</td></tr> <tr><td>SZVMAS043</td><td>5.3</td><td>1.4</td><td>0.4</td><td>P&amp;C NorthStar, App, PT</td></tr> <tr><td>SZVMDS007</td><td>5.3</td><td>5.9</td><td>1.2</td><td>P&amp;C Shared, DB, PT</td></tr> <tr><td>SZVMDS100</td><td>4.5</td><td>6.2</td><td>0.1</td><td>P&amp;C Agent Gateway DB, ST</td></tr> <tr><td>SZVMAS027</td><td>4.4</td><td>1.6</td><td>3.5</td><td>P&amp;C Customer Endpoint, App, PT</td></tr> <tr><td>SZVMAS029</td><td>4.2</td><td>1.0</td><td>0.4</td><td>P&amp;C, App, PT</td></tr> <tr><td>SZVMDS003</td><td>3.8</td><td>3.4</td><td>0.7</td><td>P&amp;C SRS/ARAS, WAS, DB, PT</td></tr> <tr><td>SZVMDS104</td><td>3.8</td><td>2.6</td><td>0.2</td><td>P&amp;C Vin / Vms Lookup / Nol, DB, ST</td></tr> </tbody> </table>					Host/uid:	CPU%	IO/Sec	Pg/Sec	Description	SZVMAS100	30.0	0.7	0.1	P&C Agent Gateway WAS App, ST	SZVMAS110	11.7 C	5.9	2.5	10:03 P&C Agent Gateway, WAS, ST	SZVMAS021	6.0	1.8	0.6	P&C MarketLink, App, PT	SZVMAS031	5.3	1.4	3.4	P&C Northstar, App, PT	SZVMAS043	5.3	1.4	0.4	P&C NorthStar, App, PT	SZVMDS007	5.3	5.9	1.2	P&C Shared, DB, PT	SZVMDS100	4.5	6.2	0.1	P&C Agent Gateway DB, ST	SZVMAS027	4.4	1.6	3.5	P&C Customer Endpoint, App, PT	SZVMAS029	4.2	1.0	0.4	P&C, App, PT	SZVMDS003	3.8	3.4	0.7	P&C SRS/ARAS, WAS, DB, PT	SZVMDS104	3.8	2.6	0.2	P&C Vin / Vms Lookup / Nol, DB, ST
Host/uid:	CPU%	IO/Sec	Pg/Sec	Description																																																																																																																													
SZVMDS001	101.4	6641.0	2.4	P&C Agent Gateway Data, PT																																																																																																																													
SZVMAS551	98.8	1.9	0	NSC Tops, WAS ND App, DEV																																																																																																																													
SZVMAS430	95.5	1.0	1.1	P&C NWBH, App, DEV																																																																																																																													
SZVMAS050	30.4	0.8	0.8	P&C Agent Gateway WAS App, IT																																																																																																																													
SZVMAS028	7.9	1.0	0.5	P&C, App, PT																																																																																																																													
SZVMAS026	5.8	3.3	0.6	P&C Customer Endpoint, App, PT																																																																																																																													
SZVMAS504	5.6	1.4	2.1	NSC Nationwide.com, App, ST																																																																																																																													
SZVMAS032	5.3	1.4	0.6	P&C Northstar, App, PT																																																																																																																													
SZVMAS044	4.7	1.9	0.7	P&C NorthStar, App, PT																																																																																																																													
SZVMDS002	4.7	7.8	1.4	P&C Agent Gateway Data, PT																																																																																																																													
SZVMAS550	4.4 C	1.2	0	13:49 NSC Nationwide.Com WAS App, IT																																																																																																																													
Host/uid:	CPU%	IO/Sec	Pg/Sec	Description																																																																																																																													
SZVMAS100	30.0	0.7	0.1	P&C Agent Gateway WAS App, ST																																																																																																																													
SZVMAS110	11.7 C	5.9	2.5	10:03 P&C Agent Gateway, WAS, ST																																																																																																																													
SZVMAS021	6.0	1.8	0.6	P&C MarketLink, App, PT																																																																																																																													
SZVMAS031	5.3	1.4	3.4	P&C Northstar, App, PT																																																																																																																													
SZVMAS043	5.3	1.4	0.4	P&C NorthStar, App, PT																																																																																																																													
SZVMDS007	5.3	5.9	1.2	P&C Shared, DB, PT																																																																																																																													
SZVMDS100	4.5	6.2	0.1	P&C Agent Gateway DB, ST																																																																																																																													
SZVMAS027	4.4	1.6	3.5	P&C Customer Endpoint, App, PT																																																																																																																													
SZVMAS029	4.2	1.0	0.4	P&C, App, PT																																																																																																																													
SZVMDS003	3.8	3.4	0.7	P&C SRS/ARAS, WAS, DB, PT																																																																																																																													
SZVMDS104	3.8	2.6	0.2	P&C Vin / Vms Lookup / Nol, DB, ST																																																																																																																													
58.2%																																																																																																																																	

# So, where are we now?



- zLinux Total Cost of Ownership is *far* lower, provides faster roll-out (provisioning) and more services (DR) are included than any other platform alternative
- Over 500 virtual Linux servers active w/over 1600 jvms
- 18+ live production applications
  - <http://www.nationwide.com> – the web front door to Nationwide Insurance. It was tested at 22 times its anticipated peak and still performed acceptably
  - More production applications in progress
- Forecasting indicates zLinux growth to continue at a high rate
- The zLinux project *has* and *is* saving **millions of dollars**

# So, where are we now?



- You may ask, are we all warm and fuzzy with zLinux now?
  - The short answer is, “Mostly”
  - There are still a few that try to say the mainframe is too expensive
    - We have to repeat the story a few times and show the facts again
    - The biggest challenges are not technical but organizational
    - Some of our best references are the ones we had the most trouble with in the beginning!
  - It is still easily proven that it is the Right Thing to be doing for the business!
- With zLinux, working with z/VM is a COOL place to be now!





# So does this stuff really work??!



**InformationWeek**  
BUSINESS INNOVATION POWERED BY TECHNOLOGY

NEWS | WINDOWS | SECURITY | OUTSOURCING | INTERNET | SOFTWARE | HARDWARE

Management Tech Center: • Careers • Management/Careers Blog • Best Practices • Jobs • InformationWeek Download • Compliance

### Nationwide Virtualizes With A Vengeance; 700 Servers Gone

Scott Miggo, VP of technology solutions, has replaced more than 700 Intel and Unix small servers with two refrigerator-sized boxes -- IBM z9 mainframes.

By [Charles Babcock](#)  
InformationWeek  
Dec 18, 2006 09:00 AM

Server consolidation in the data center usually means rolling up seven or eight low-end Intel or Unix servers into a single small server box.

**SearchCIO.com**

HOME | NEWS | MAGAZINE | CIO RESOURCES | WEBCASTS | WHITE PAPERS

SEARCH: [input] | ADVANCED SEARCH | SITE MAP | search powered by: [input]

TechTarget Events, the most targeted events for today's top enterprise pros. [View full schedule of upcoming topics and dates!](#)

HOME > CIO News > Nationwide Insurance swaps servers for virtualized mainframes

### CIO News: Headlines

#### NATIONWIDE INSURANCE SWAPS SERVERS FOR VIRTUALIZED MAINFRAMES

By Shamus McGillicuddy, News Writer  
12.06.2006 | SearchCIO.com

RSS FEEDS: IT news and analysis  
[RSS] [Add]

When Buzz Woeckener joined Nationwide, he was suffering from a serious case of...

**INSURANCE & TECHNOLOGY**

NEWS | EVENTS | TOOLS

CONNECTED ENTERPRISE

### Linux Levels the OS Field?

No longer bogged down in proprietary, noninteroperable environments, insurers must carefully consider the complex array of open source choices they now have.

By Peggy Bresnick Kendler  
[Insurance & Technology](#)  
December 13, 2006

#### Q: What's the current status of Linux/open source adoption in financial services?

A: Guru Vasudeva, [Nationwide](#): Adoption is increasing [because] ... people are finding that it's not just an economic driver anymore to save some licensing costs. More and more people are skilled in the marketplace in these open systems rather than in traditional, proprietary systems. There are definitely some obstacles to adoption, such as the increasing complexity of licenses that are attached to these open source systems. We started off with two or three...

**IBM**

United States [change] | Terms of use

Press room [dropdown]

Home | Products | Services & industry solutions | Support & downloads | My IBM

### Nationwide deploys virtualization computing solution on Linux

Intent to save millions over the next three years

**Press releases**

**Press kits**

**Photo gallery**

**Biographies**

**Background**

**Press room feeds**

**Global press resources**

**Press room search**

**Media contacts**

**Columbus, Ohio - 15 Aug 2006:** Nationwide, one of the world's largest diversified insurance and financial services organizations, announced it has completed deployment of a virtualization solution running SUSE Linux from Novell on IBM mainframe computers to help the company reduce the total cost of ownership of its IT environment. Nationwide is sharing the success of the solution by participating in a keynote presentation at LinuxWorld on August 16.

Running two IBM System z900 servers on Linux, Nationwide is deploying hundreds of virtual servers onto the mainframe systems to help it reduce the costs of data-center floor space, power, and Web hosting. A study in 2005 suggested the savings could be tens of millions of dollars over the next three years.

# ...and more!

## Nationwide Deploys Virtualization Computing Solution on Linux

Intent to save millions over the next three years

COLUMBUS, Ohio, Aug. 15 /PRNewswire/ -- Nationwide, one of the world's largest diversified insurance and financial services organizations, announced it has completed deployment of a SUSE Linux from Novell on IBM mainframe computers to reduce the total cost of ownership of its mainframe computing environment. Nationwide is sharing the success of the solution by participating in a panel presentation at LinuxWorld on August 16.



**Enterprise Systems**  
Mainframe and High-end Server Solutions in Focus

- News
- Enterprise
- Security

[Home](#) | [About ES](#) | [Sub](#)

### Enterprise

## Customers Get Hip to System z Value Proposition

Are a pair of recent Intel-to-System z defections a harbinger of what's to come?

by Stephen Swoyer

# GRID today



The Leading Source for Global News and Information from the evolving Grid including Grid, SOA, Virtualization, Storage, Networking and Service

[Home Page](#)

### Operating Systems & Middleware:

## IBM Unveils Roadmap for Open Source Beyond Linux

IBM rolled out its next generation blueprint and roadmap to advance key priorities and support for open source business models.

With this news, IBM announced Brazilian-based online gaming pioneer Hop.com. Nationwide Insurance, CommX, and RealPlus are among those pushing the number of Linux-related customer engagements to more than 15,000 worldwide.

## Z JOURNAL

[about us](#) | [editorial calendar](#) | [advertising](#)

[ISSUES](#) [ARTICLES](#)

### z/RESOURCES

- industry news
- white papers
- quick quiz
- events

**SUBSCRIBE**

June/July 2006 ::

## Insider Insights: Linux on the Mainframe Provides Big Savings for Nationwide Insurance

by Bill Carico

[> email article](#)  
[> print-friendly](#)

ZJournal interviews Steve Womer, a senior consulting IT Architect at Nationwide Insurance, who has more than 27 years of experience in mainframe and distributed systems. For the past five years, Steve has been designing and implementing Linux solutions across various platforms.

# Conclusions



- Linux definitely is Linux – the same on all platforms
  - Code written for Linux on any platform can usually be used on any other platform that supports Linux with only a recompile (usually)
- Linux virtualization on zSeries can and does:
  - Reduce cost
    - Just software costs per engine can save you BIG \$\$
      - Simple math – note the difference in cost:  
Take 100 servers on dual-core Intels -  $\$LicenseCost * 200$   
Take 100 servers on 15 IFL z990 (huge!) -  $\$LicenseCost * 15$
  - Reduce complexity
    - Sharing R/O DASD, less complex network (wires), etc
  - Accelerate provisioning
    - Feasible to provision servers in minutes
  - Reduce human error of manual installation, configuration and even patching

# Conclusions



- Not every workload is suited to Linux on zSeries
  - But you have to try it for yourself
  - What wasn't good even a year ago probably fits now
- Not all software is ready for Linux on zSeries
  - But you really should ask for it to be
- Things are changing rapidly
- Be careful what you ask for because you may get it!

OUR SERVERS ARE USING TOO MUCH ELECTRICITY. WE NEED TO VIRTUALIZE.

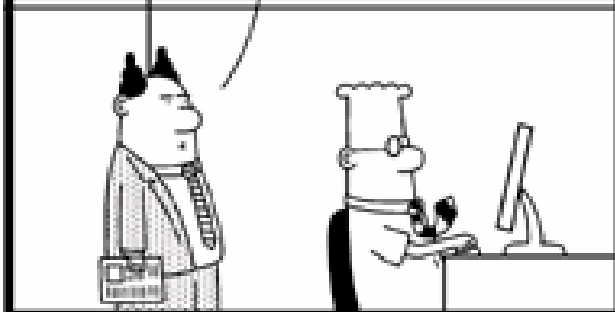

www.dilbert.com scottadams@aol.com

I DID MY PART BY READING ABOUT VIRTUALIZATION IN A TRADE JOURNAL. NOW YOU DO THE SOFTWARE PART.

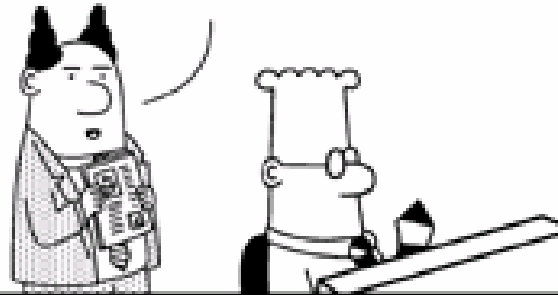

2-13-08 © 2008 Scott Adams, Inc./Dist. by UFS, Inc.

WHY IS YOUR PART TAKING SO LONG?

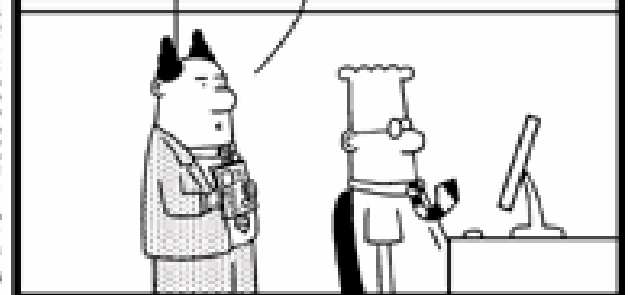

© Scott Adams, Inc./Dist. by UFS, Inc.

I HIRED A CONSULTANT TO HELP WITH OUR VIRTUALIZATION PROJECT BECAUSE I DON'T TRUST EMPLOYEES WITH ANYTHING IMPORTANT.

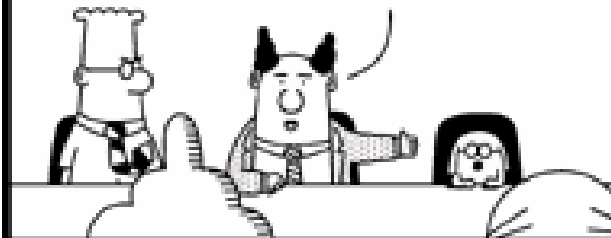

www.dilbert.com scottadams@aol.com

I WILL DO THE HEAVY THINKING WHILE EACH OF YOU PERFORMS YOUR USUAL DUTIES AS OBSTACLES TO PROGRESS.

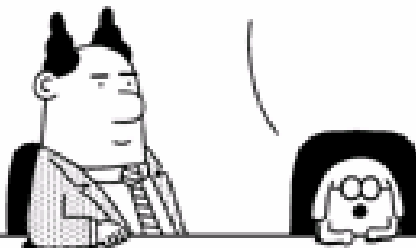

2-13-08 © 2008 Scott Adams, Inc./Dist. by UFS, Inc.

YOU SAID THIS IS MY PROJECT!

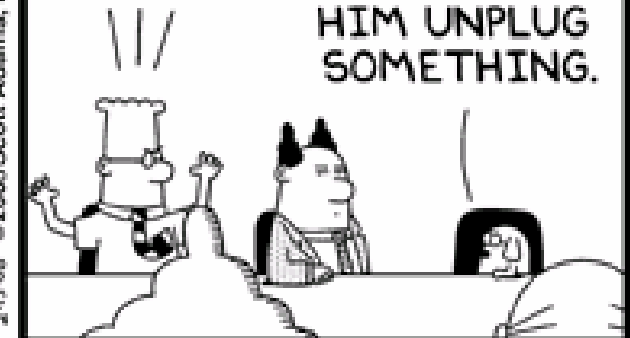

I'LL LET HIM UNPLUG SOMETHING.

© Scott Adams, Inc./Dist. by UFS, Inc.

# Contact Info



LIGHT TRAVELS FASTER THAN SOUND, THAT'S WHY PEOPLE  
SEEM BRIGHT UNTIL YOU HEAR THEM...



**Jim Vincent**  
Senior z/VM Systems Programmer

Phone: (614) 249-5547  
Internet: [James.Vincent@nationwide.com](mailto:James.Vincent@nationwide.com)

# Article references



- <http://www.informationweek.com/story/showArticle.jhtml?articleID=196700327>
- [http://searchcio.techtarget.com/originalContent/0,289142,sid19\\_gci1233267,00.html](http://searchcio.techtarget.com/originalContent/0,289142,sid19_gci1233267,00.html)
- <http://www-03.ibm.com/press/us/en/pressrelease/20132.wss>
- <http://www.insurancetech.com/news/showArticle.jhtml?articleID=196604002>
- <http://www.prnewswire.com/cgi-bin/stories.pl?ACCT=104&STORY=/www/story/08-15-2006/0004416458>
- <http://esj.com/enterprise/article.aspx?EditorialsID=2106>
- <http://www.gridtoday.com/grid/814886.html>
- <http://www.zjournal.com/index.cfm?section=article&aid=394>